

投資人交流會議 Investor Conference

2022.3



Oriental Union Chemical Corp.



Company Profile

Est. 1975

Capital: NT 8.86B

Shareholders: 63,087

Production sites:

Kaohsiung

Yangzhou





Production Lines

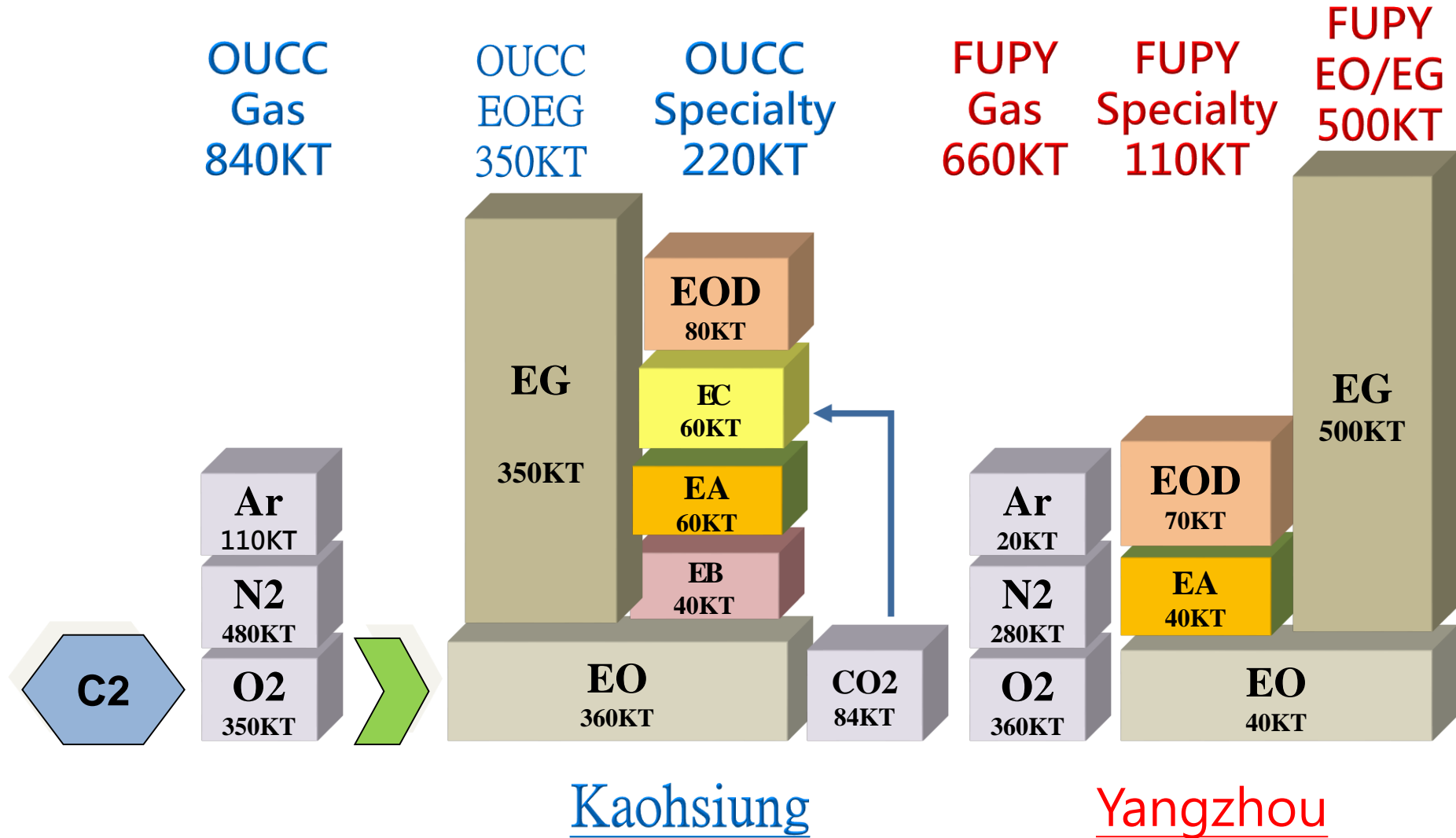



Raw Material

OUCC Products

Applications



原油
Crude Oil

輕油裂解
Cracker

乙烯
Ethylene

空氣
Air

環氧乙烷
EO

乙二醇 (EG) *

乙醇胺 (EA) *

乙二醇丁醚 (EB/DB/TB)

碳酸乙烯酯 (EC)

環氧乙烷衍生物(EOD) *

聚醚胺PEA/乙二胺EDA

氧氣(O2) *

氮氣(N2) *

氫氣(Lar) *

二氧化碳(CO2)

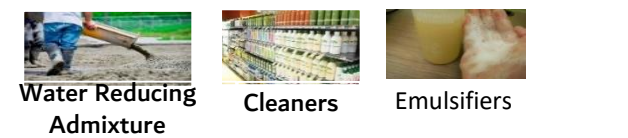
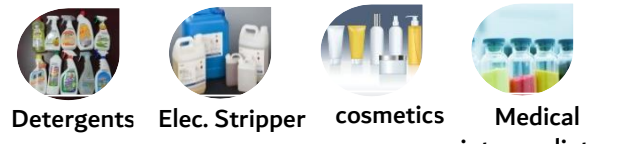

* Items produced in both sites

Under Construction



2020/2021 Consolidated Revenue, P/L



Revenue: NT 100 million (億)

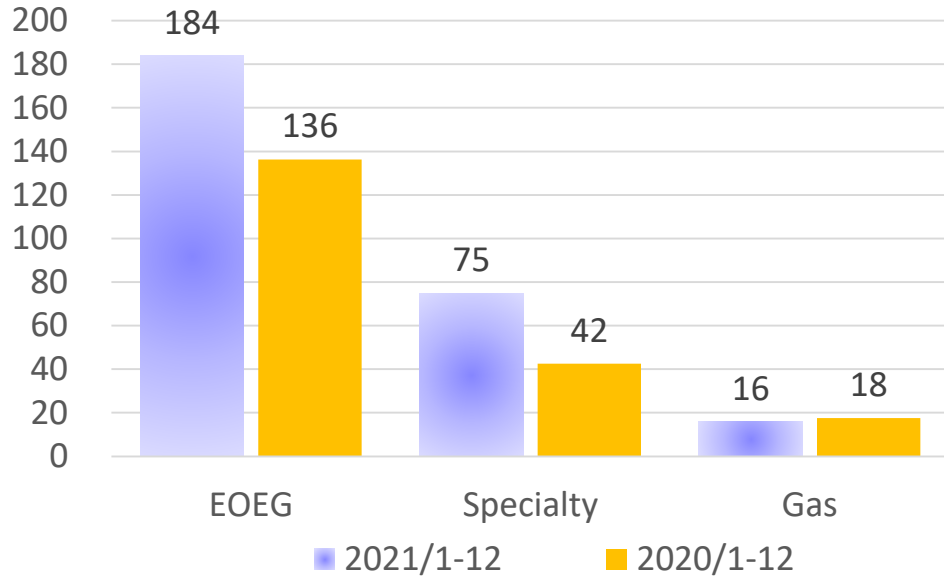

Revenue: NT 100 million (億)

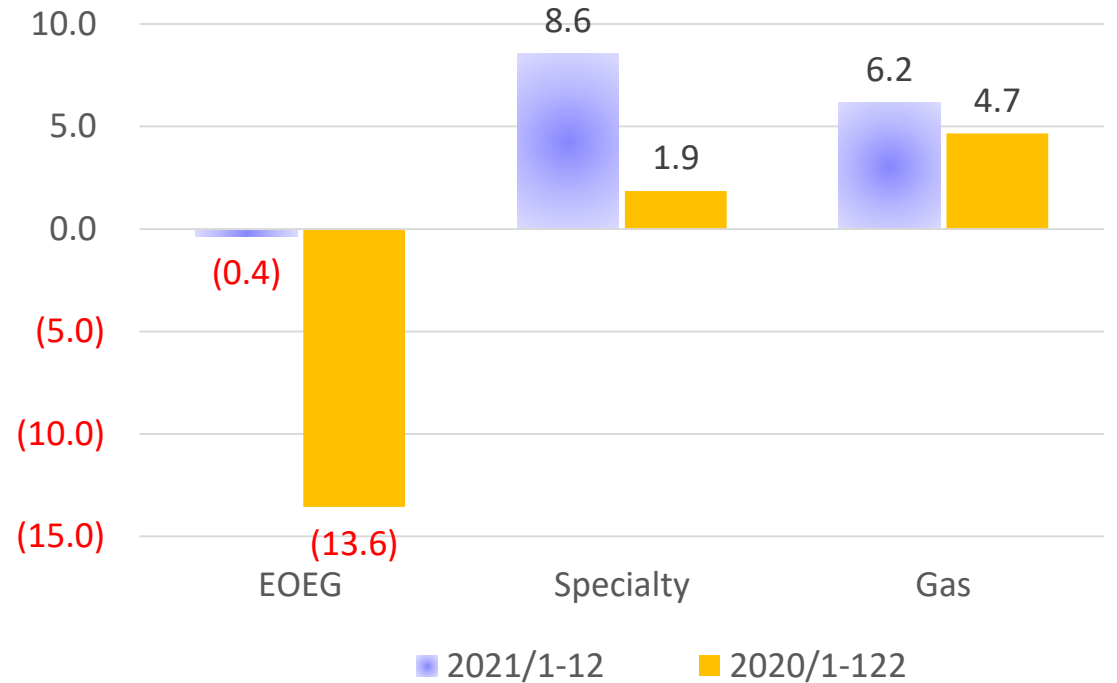

2021/1-12

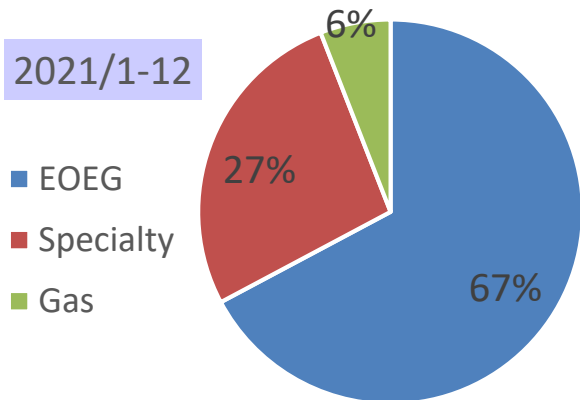

2020/1-12

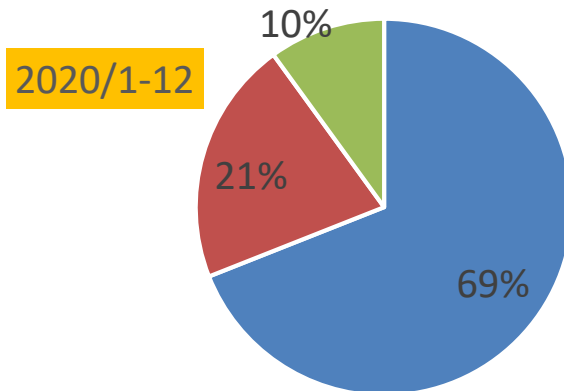



Thanks for your attention

簡報完畢

  **東聯化學**
ORIENTAL UNION CHEMICAL CORPORATION